

STAYFLEX

Corrosion Control and Thermal Insulation Systems



*15 Year Proven
Performance in
Chemically Strong
and Wet Environments*



PSI
PREFERRED SOLUTIONS, INC.

Systems Description

Stayflex Systems are spray-applied in a two layer composite. Staycell closed-cell polyurethane foam insulation is first applied with typical thicknesses ranging from 1/4" - 1". Its high thermal efficiency rating of R-8 per inch is approximately twice that of most insulation materials. The seamless Staycell foam is a Class A fire rated material and achieves excellent adhesion to most substrates including locations where corrosion has occurred. The foam performs as a thick, strong and tenacious primer and base for encasement with the Stayflex chemical resistant finish.

The Stayflex protective surface is an unsaturated polyester resin material, commonly referred to as "fiberglass", used to manufacture gasoline and chemical tanks, fume hoods and other products that must withstand highly corrosive environments. Stayflex is applied at 1/16" or greater thicknesses over the Staycell foam to provide a chemically resistant, water vapor barrier to protect the foam and the steel substrate. Stayflex is a Class A, fireproofing material enabling the system to achieve national compliance with insurance and building code requirements.

Stayflex Systems are suitable for interior and exterior applications, are approved by the U.S. Department of Agriculture for use in food processing plants and are available in a wide variety of colors.

STAYFLEX SYSTEM DESIGN

- A 1/4"-1" Staycell provides a resilient interlayer to accommodate expansion and contraction.
- B 1/16" Stayflex protective surface.

- Thickness and low permeability of Staycell and Stayflex minimize air, oxygen, chemical fumes and water vapors from reaching steel.

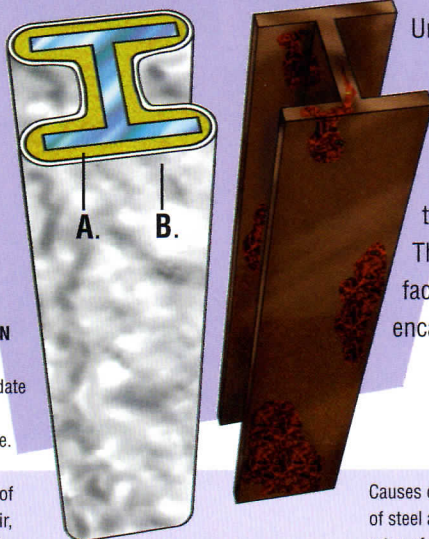

Corrosion and Condensation Control for Structural Steel

Standard practice to protect steel from corrosion has been to abrasive blast, prime and paint the steel with two coats of high quality paints at thicknesses approximating .006". These painting systems only perform for 2-3 years before paint peels and corrosion occurs for two primary reasons:

The paints are permeable which allows water vapor and chemical fumes to reach the steel surface and corrosion begins thus forcing the paint off. Additionally, the steel expands and contracts at different rates than paint and shear forces cause failure of the paint bond.

Stayflex Systems overcome these limitations by applying a 1/4" - 1" thick structural shell. No water or solvents are in the materials which results in very low permeability thus reducing or preventing steel corrosion by blocking air and oxygen. The integrity of the system is maintained by using the resilient Staycell foam interlayer as a "shock absorber" that accommodates the different expansion and contraction rates of the steel and Stayflex surface.

Unlike paints requiring meticulous surface preparation, Stayflex Systems need minimal surface preparation due to their overall thicknesses and strengths. This is similar to minimal surface preparation required for encasement of steel in concrete.

Causes of paint failure and corrosion of steel are due to different expansion rates of the paint and steel. Bond failure also caused by water vapor and chemical fumes passing through permeable paints.

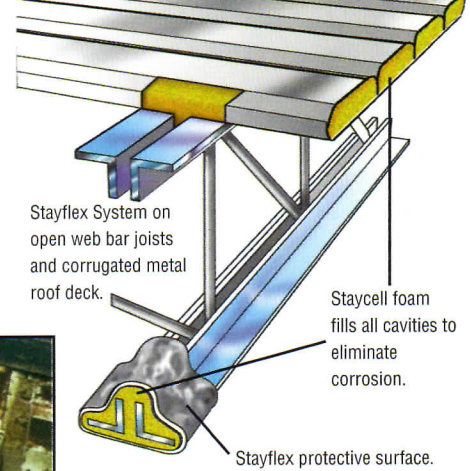

Concealed or difficult access locations often prevent proper surface preparation and painting as shown above. On open web bar joists and corrugated metal roofing,

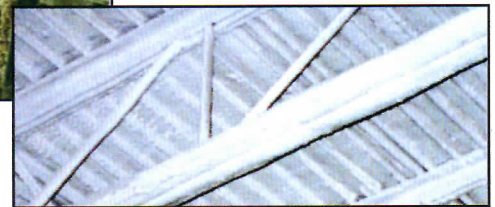

The above photos illustrate how concealed and difficult areas are completely encased for maximum protection with the Stayflex System.

the Staycell foam is used to fill these spaces thus fully protecting all surfaces from corrosion.

Test data verifies Stayflex Systems can be applied over lead-based paint without creating unacceptable levels of airborne lead. Compliance with EPA and OSHA regulations is greatly simplified and achieved at lower costs than traditional surface preparation and painting.



Beams Before



Beams After

Corrosion Control and Insulation on Steel Roofs, Siding and Other Steel Surfaces.

Traditional spray-applied insulation materials are porous and allow water vapor and chemical fumes to pass through thus permitting corrosion to occur. Fiberglass blanket insulation with white vinyl, vapor barrier facing is often used as a preferable approach. Unfortunately, fiberglass blankets also have several significant limitations: The materials are typically installed on the exterior side of the structural steel and do not protect the steel members from corrosion and condensation. The insulation is not adhered directly to the roof or siding and results in the steel being exposed to air.



Roof Deck and Joists, before

The seams between the blankets cannot be maintained in a vapor proof condition which allows water vapor and chemical fumes to enter into and behind the insulation. This results in moisture absorption, loss of thermal resistance and corrosion of the steel behind the blankets.

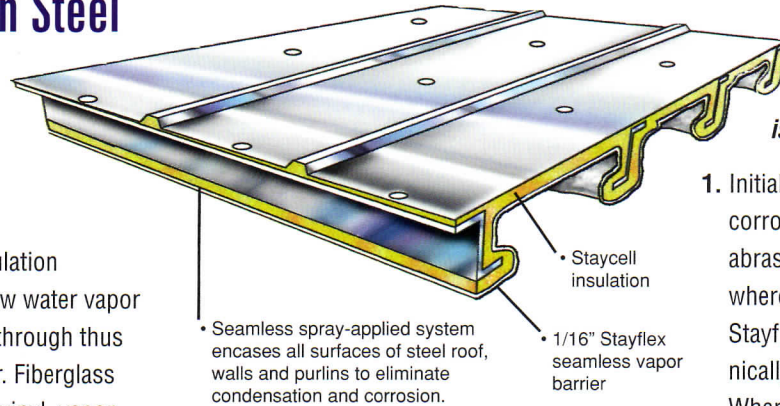
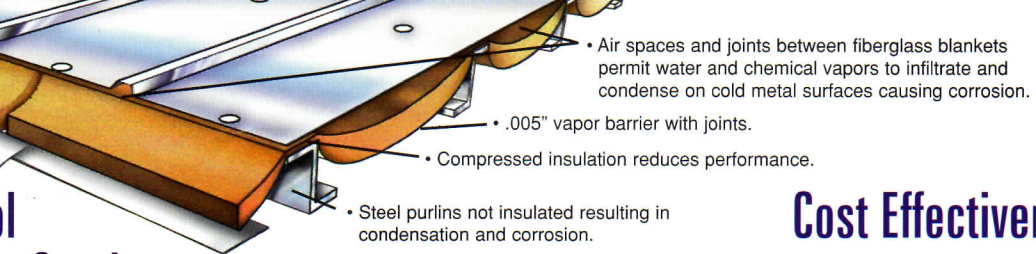

The Stayflex Systems offset these limitations by being spray-applied directly in contact with all steel surfaces. The systems provide a chemical resistant, seamless, water vapor barrier which prevents corrosion and condensation.

The systems are used in new construction as well as buildings where corrosion is already occurring. The technology can greatly extend the service life of corroded steel that otherwise would need to be replaced.



Completed Installation

Cost Effectiveness

The excellent cost effectiveness of the Stayflex Corrosion Control and Insulation Systems is achieved in three ways:

1. Initial costs are comparable to typical corrosion control methods such as abrasive blasting and repainting. In cases where ordinary solutions are not feasible, Stayflex Systems are often the most technically and economically viable solution. Where lead-based paint is present on the substrate, the ability to apply the Stayflex Systems with minimal surface preparation nor disturbance is resulting in significant cost savings compared to standard surface preparation and painting. In thermal insulation applications, initial costs are often competitive with traditional insulation systems.
2. Stayflex Systems are installed in a quick and clean manner. No water or solvents are in the materials which enables them to be sprayed at low temperatures with fast curing. Dollars are saved since normal building operations and production schedules can be maintained with minimal disruption. 15,000 to 20,000 square foot projects can be completed in a single weekend.
3. The superior performance results in a system that is essentially maintenance free with 15 year documented performance history. This usually provides the lowest annual cost for any corrosion control or thermal insulation system currently available.

Cash inflows from energy savings can be achieved instead of continual spending on approaches such as painting that do not provide insulation.

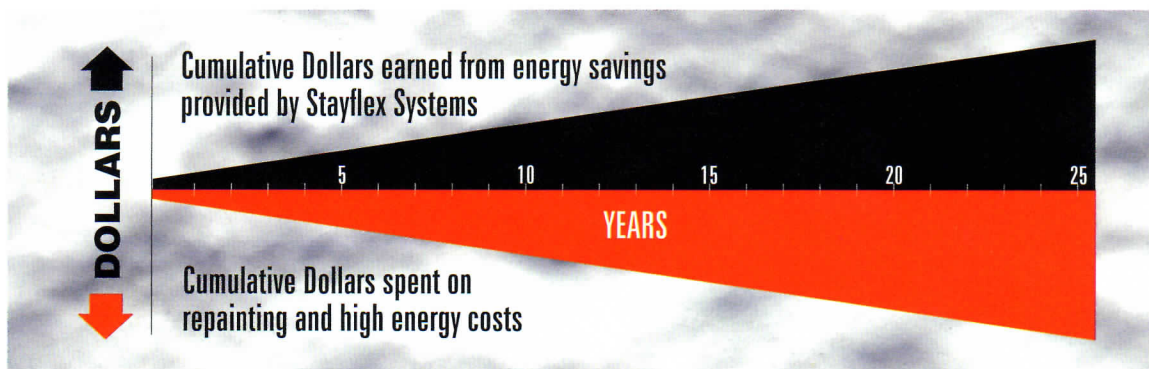

Independent Laboratory Documentation

Independent testing laboratories specializing in the testing of steel for corrosion and serviceability have documented the long-term effectiveness of Stayflex Systems to prevent corrosion of steel substrates in chemically strong environments including hydrochloric, sulfuric and nitric acid liquids and vapors. One laboratory, World International Testing, Inc. has issued a report: *Investigation of the long-term performance of the Stayflex corrosion control system in chemically strong environments - a 10 year service study.*



Roof Decks



Walls

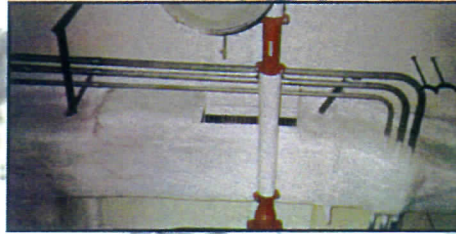

Ductwork

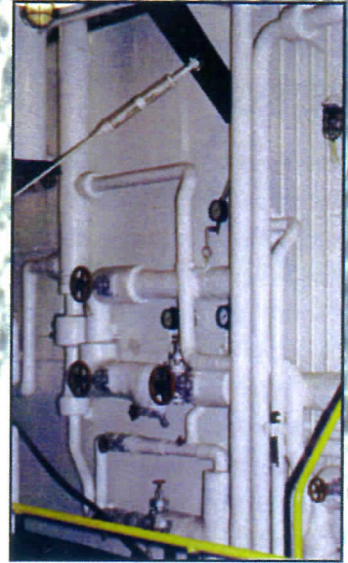

Piping



Tanks



The report verifies through core sampling and ultrasonic testing the unique long-term performance of the Stayflex Systems.

Additional Data

Technical data, material safety data sheets, application instructions, case histories, approvals, pay back calculations and other information are available upon request.

Availability

Stayflex Corrosion Control and Thermal Insulation Systems are installed throughout the United States by Authorized Stayflex Applicators. Phone us at our toll-free number to determine how Stayflex Systems can be your most cost effective and preferred solution for corrosion control and energy savings.

Representative Completed Projects

INDUSTRIAL

Alcoa
Akzo Salt
Campbell Soup Company
Chicago Bridge and Iron
Dow Chemical Company
Dupont
Ford Motor Company
General Motors Corporation
Kraft Foods
LTV Steel
William G. Mather Ore Boat
Merck Drug
Midland Steel
Olin Chemical Company
Rohm and Haas
SCM Chemicals

Stouffers Foods
Sweetheart Cup
Thomas Strip Steel
Uniroyal
USX Corporation
WCI Steel
White Consolidated Ind.

COMMERCIAL

BASF
Baxter Drug
Disney World
Empire State Building
Equitable Realty
Fairmont Hotel
Macy's
Prudential Realty

Sheraton Hotels
Teacher's Pension Fund
Universal Studios
Charleston National Bank
Society National Bank
Caterpillar

GOVERNMENTAL

Lawrence Livermore Lab.
NASA
Oklahoma County Gov't
U.S. Air Force
U.S. Army
U.S. Department of Energy
U.S. General Services Adm.
U.S. Navy
U.S. Veterans Adm.

Toll-Free Phone Number
1-800-522-4522

PSI

PREFERRED SOLUTIONS, INC.
7819 Broadview Road
Cleveland, Ohio 44131
(216)-642-1200 • Fax (216)-642-1166

This Information is based on tests believed to be reliable and are given for information only. Since conditions of use are beyond our control, we cannot and do not assume any liability in connection with the use of the products relative to coverage, performance or injury. Nothing contained herein shall be construed as a recommendation to use these products in conflict with any existing patents.